

SSA Series  
Integrated Solar Street Light  
With Adjustable Bracket



High Cost  
Performance



High Quality



High Brightness



5-7 Cloudy/  
Rainy Days



Human Body  
Induction



Remote Control



Adjustable Bracket



IP65 Waterproof

# INTRODUCTION

## Product specifications



Front Cover



Catalog



Advantages



Specifications



Exploded View



Light Distribution  
Curve



More Details



Controller Instruction



Remote Control Instruction



Dimension Figure



Adjustable Bracket  
Instruction



Package Detail



Installation Instruction



Applications

## SSA Series | Advantages



### Product Advantages:

1. Designed by a professional industrial design team, integrating solar panels, led sources, controller, battery, human body induction, and housing.
2. Adjustable angle mounting bracket, suitable for a variety of modeling lamp pole installation methods.
3. Intelligent power adjustment, automatic weather judgment, reasonable planning of discharge rules.
4. Intelligent charging and discharging management, soft and hard double protection of charging and discharging and intelligent equalization technology, battery cycles more than 2000 times.
5. Smart remote control, equipped with drone remote control, ultra-long remote control distance of 30 meters, can pass through obstacles, and can set four lighting modes at will.
6. High-efficiency LED chips can reach 220LM/W, which is more than twice the average brightness of ordinary LED light sources, with a luminous angle of 140 degrees, and a wider irradiation area.
7. The whole lamp adopts modular minimalist design, easy disassembly, installation, and transportation.

# SSA Series | Specifications

Led Source	SSA-40W	SSA-50W	SSA-60W	SSA-80W	SSA-100W	SSA-120W
Mono Solar Panel	18V 65W	18V 70W	18V 80W	18V 100W	18V 130W	18V 140W
LifePO4 Battery	12.8V 28AH	12.8V 36AH	12.8V 42AH	12.8V 57AH	12.8V 63AH	12.8V 72AH
LED (Bridgelux)	3030/96PCS	3030/144PCS	3030/144PCS	3030/192PCS	3030/240PCS	3030/288PCS
Color Temperature	2700K-6500K, RA>70					
Brightness	170LM/W					
Working Time	12-15hours, 10-12 cloudy/ rainy days					
Charging Time	6-8hours					
Mounting Caliber	70-76mm (suggestion)					
Working Temperature	-25°C - +65°C					
Body Sensor	160°, >9m , Activated by customer's need					
Battery Power Indicators	100%-75%-50%-25%					
Fault indicator	RED/BLUE/GREEN					
IP Rating/IK Class	IP65/IK10					
Package Size	920*160*450 mm	1140*160*450 mm	1140*160*450 mm	1620*100*450/630*380*150mm	1940*100*450/630*380*150mm	1940*100*450/630*380*150mm
Gross Weight	12.2kg	14kg	14.5kg	11.2kg/8.5kg	12.5kg/9.7kg	12.5kg/10.3kg
Mounting Height	6-7m	6-8m	6-8m	8-9m	9-11m	10-12m
Space between 2 lamps	20-25m	20-25m	20-25m	25-30m	30-35m	35-40m
Warranty	3 years / 5 years					

# SSA Series | Exploded View

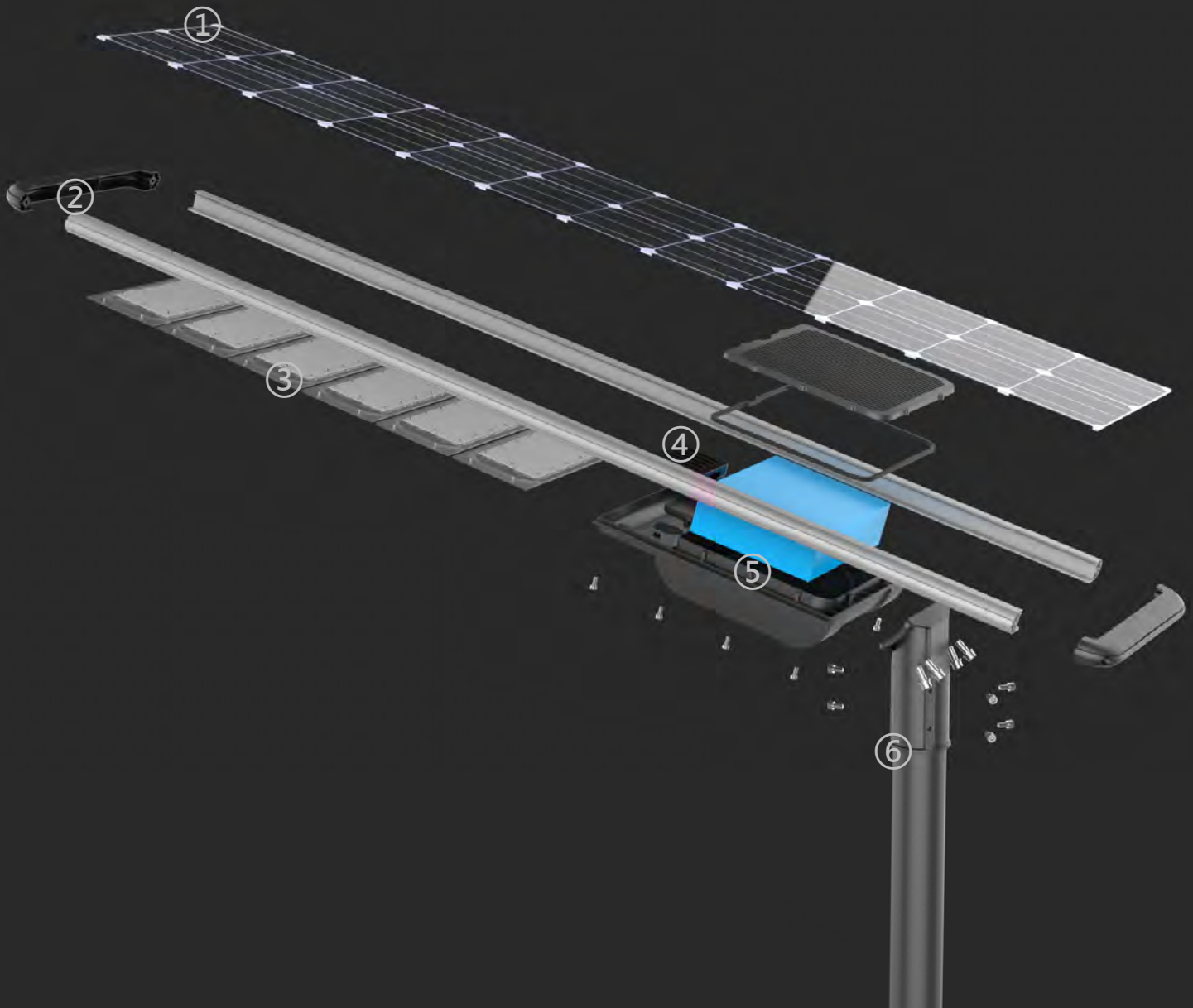

1 Solar panel

2 Lamp shell

3 LED light board + optical lens

4 Controller

5 Battery pack and battery box

6 Adjustable angle bracket

# SSA Series | Light Distribution Curve

INTENSITY DISTRIBUTION DIAGRAM  
IN C PLANS

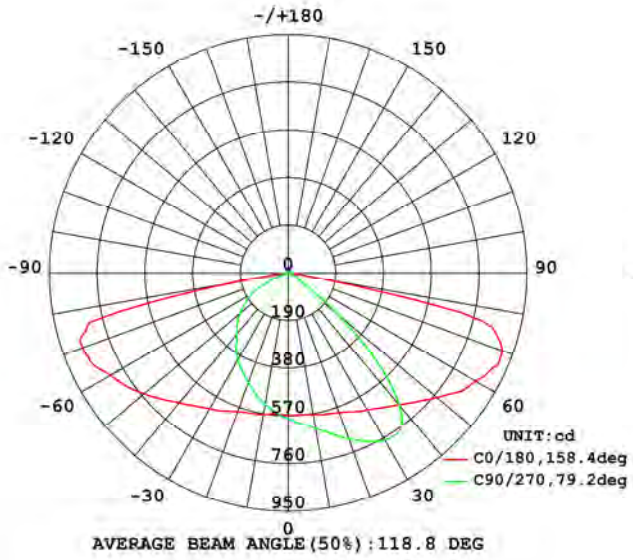

MAX INTENSITY CONE SURFACE  
DISTRIBUTION DIAGRAM

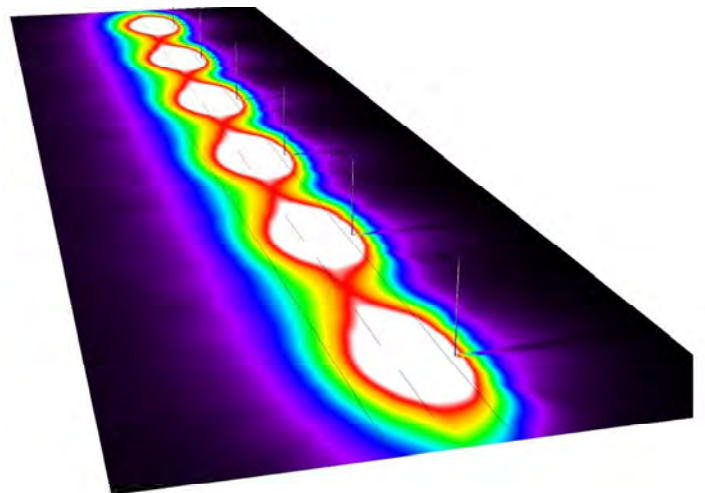
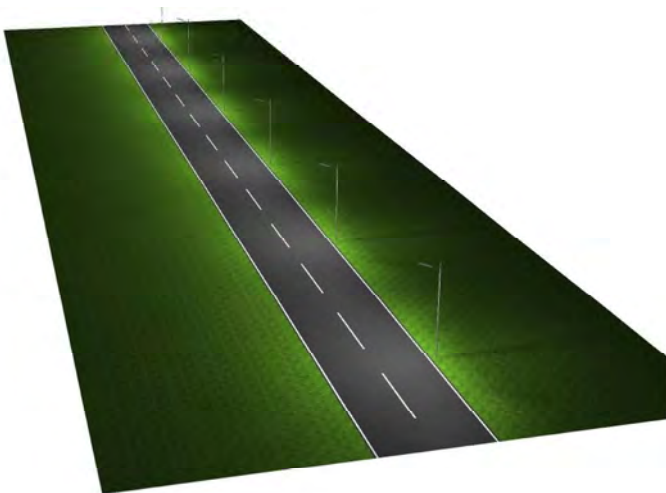
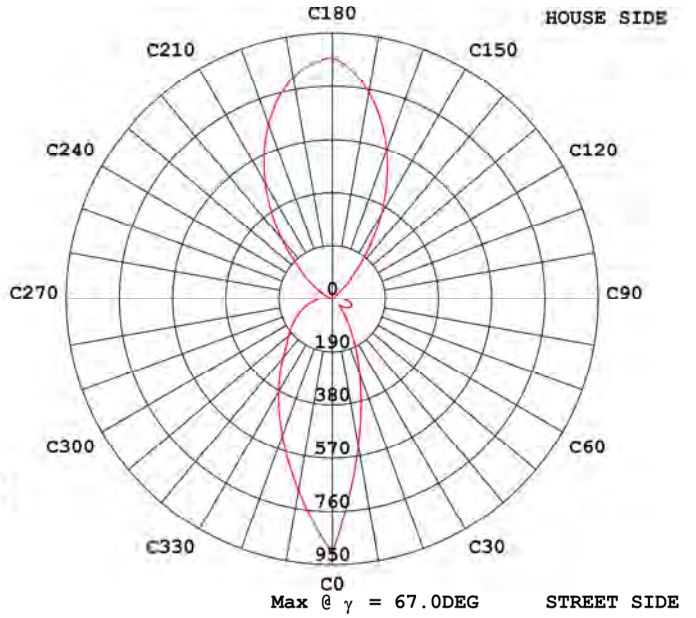

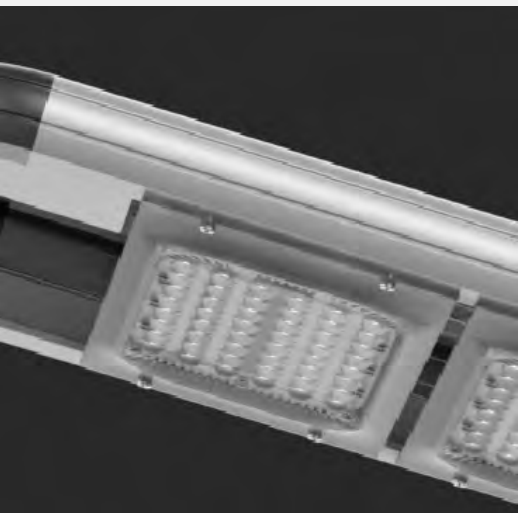

220LM/W  
high efficiency led

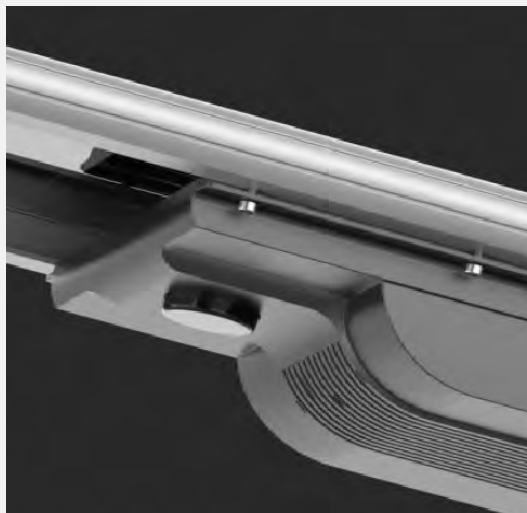

Sensor + Magnet switch  
+ Indicators for all status



0° - 90° angle  
adjustable bracket



Easy maintenance  
battery pack

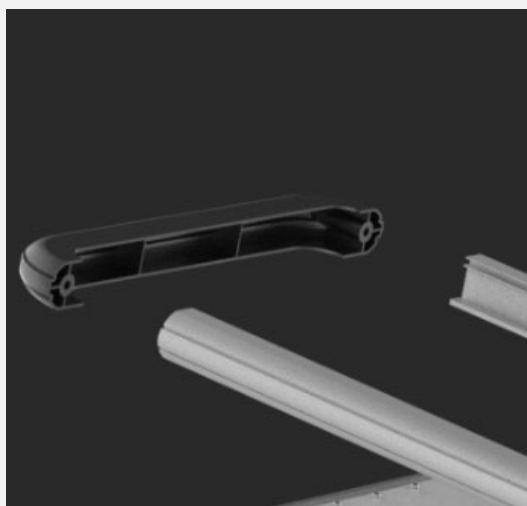

High-strength  
aluminum alloy frame

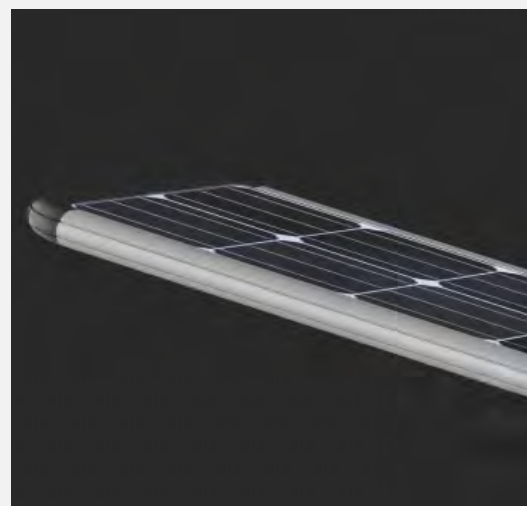

High-efficiency mono  
solar cells: >21%

The Controller of SSA series adopts extremely simplified design, integrated controller, microwave induction, and magnetic switch in one, which makes the operation simple, the maintenance simple, and the stability is higher.



## 1. Magnet Power Switch

Before mounted on the pole, take away magnet iron sheet.



## 2. Battery Power Indicators

The 4 blue LEDs in the upper row represent battery power, and 1 indicator led represents 25% power.

- 1 indicator on: 25% power
- 2 indicators on: 25%-50% power
- 3 indicators on: 50%-75% power
- 4 indicators on: 75%-100% power



## 3. Status Indicators LEDs

Solar Light Controller Status Indicator		
Indicator Light	Status	Indicator Light description
① Yellow (Motion sensor)	On	Movement Detected
	Off	Without Movement Detected
② Green (LED)	On	LED with output: Light on
	Off	LED without output: Light off
	Flicker	LED Short circuit
③ Blue (Battery)	On	Battery power enough for work
	Off	Battery Without output
	Flicker	Battery undervoltage
④ Red (Solar panel)	On	Battery charged to full power
	Off	Solar panel without output (at night)
	Flicker	Solar panel is charging the battery
⑤ Red & Green & Blue	Cycle light on in sequence	Battery cable plugged in backwards, poor battery connection contact, faulty battery, no battery connected

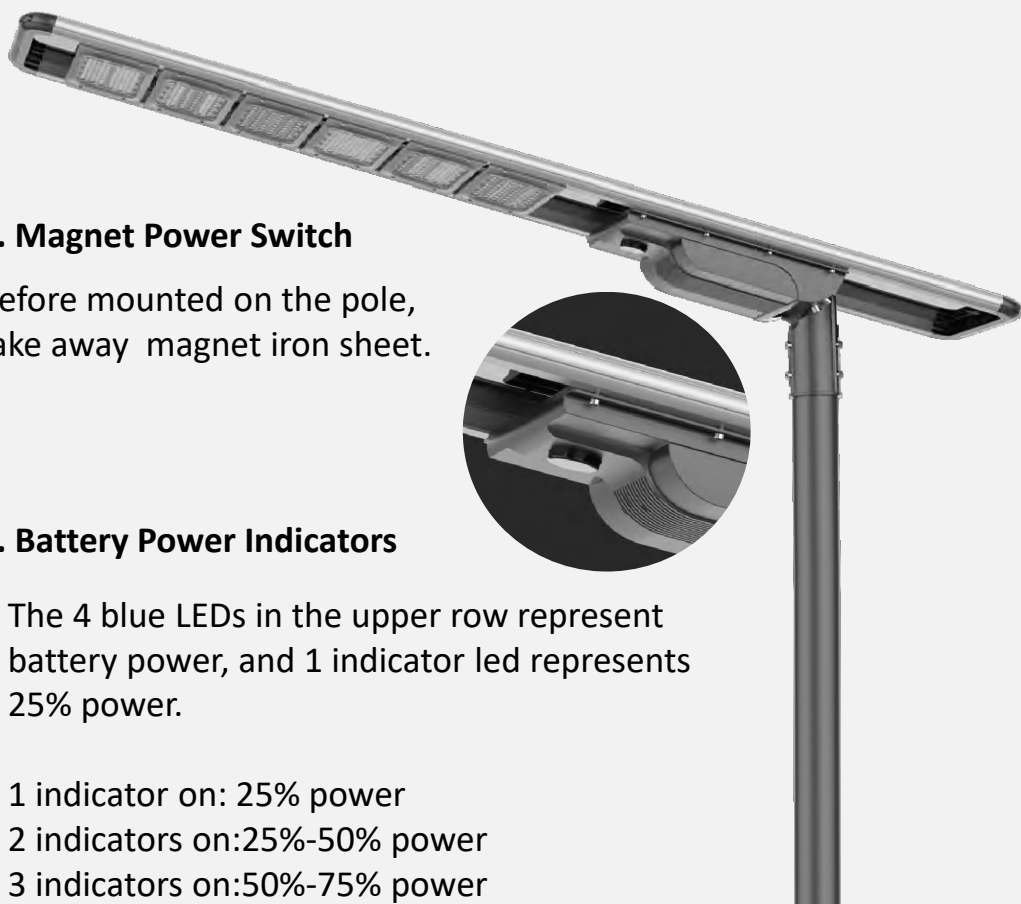





Equipped with a 433 remote control, which uses a drone remote control solution. The remote control distance can reach 30 meters, which can directly penetrate obstacles. At the same time, it can control multiple lamps.

Four lighting modes are available. The mode can be selected according to the seasonal sun. The most suitable mode can be selected according to the seasonal sunshine.

## User manual for remote controller:

**Demo:** No matter day or night, light "on" for 1 minute, only for test use.

**Off:** No matter day or night, light "OFF" .

**L:** At night, 12hrs full power.

**T:** At night, 4 hrs full power + 8 hrs 25%.

**M:** At night, 12hrs motion sensor control.

**U:** At night, 4 hrs full power + 8 hrs motion sensor control.



# SSA Series | Dimension Figure

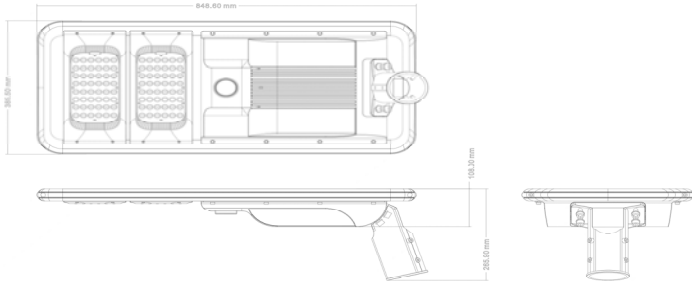

**SSA-40W**

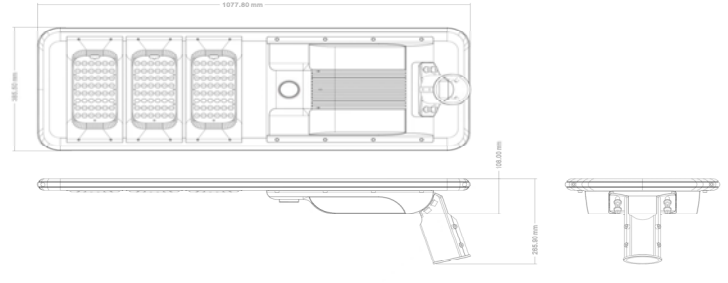

**SSA-50W/60W**

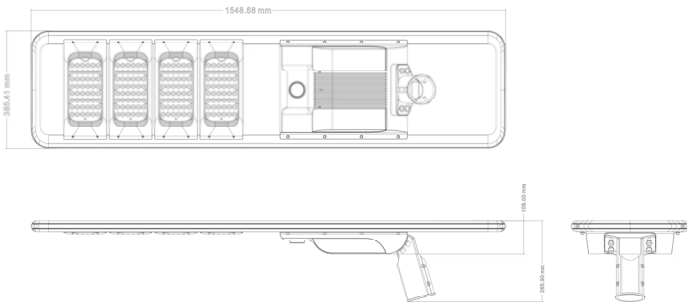

**SSA-80W**

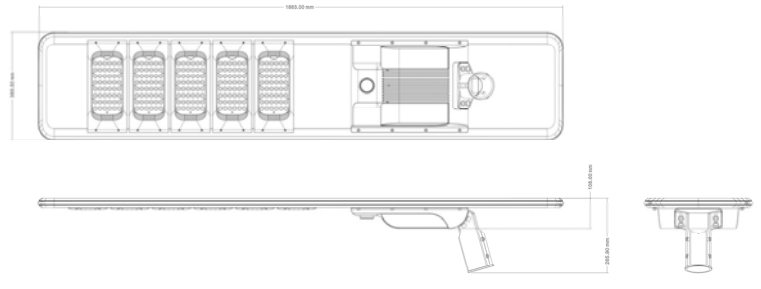

**SSA-100W**

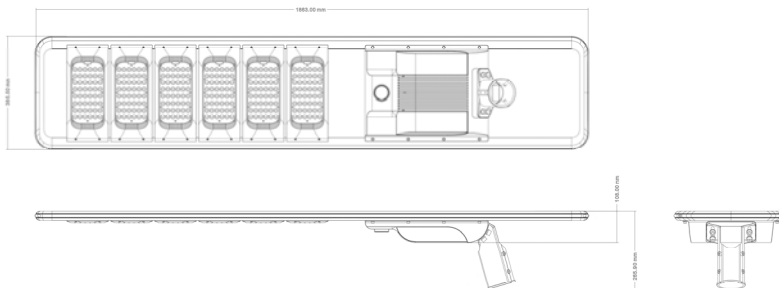

**SSA-120W**



## 2 Installation Ways for Selections

Vertical  
Installation



Horizontal  
Installation



## SSA Series | Package

### SSA-40W/SSA-50W/SSA-60W Package

1 package: 1pc lamp per carton

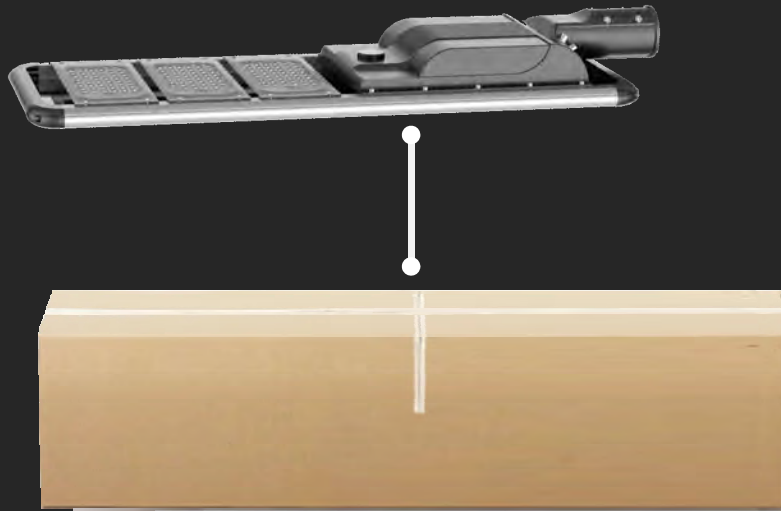

### SSA-80W/SSA-100W/SSA-120W Package

2 packages: 1pc lamp per carton + 1pc battery pack per carton

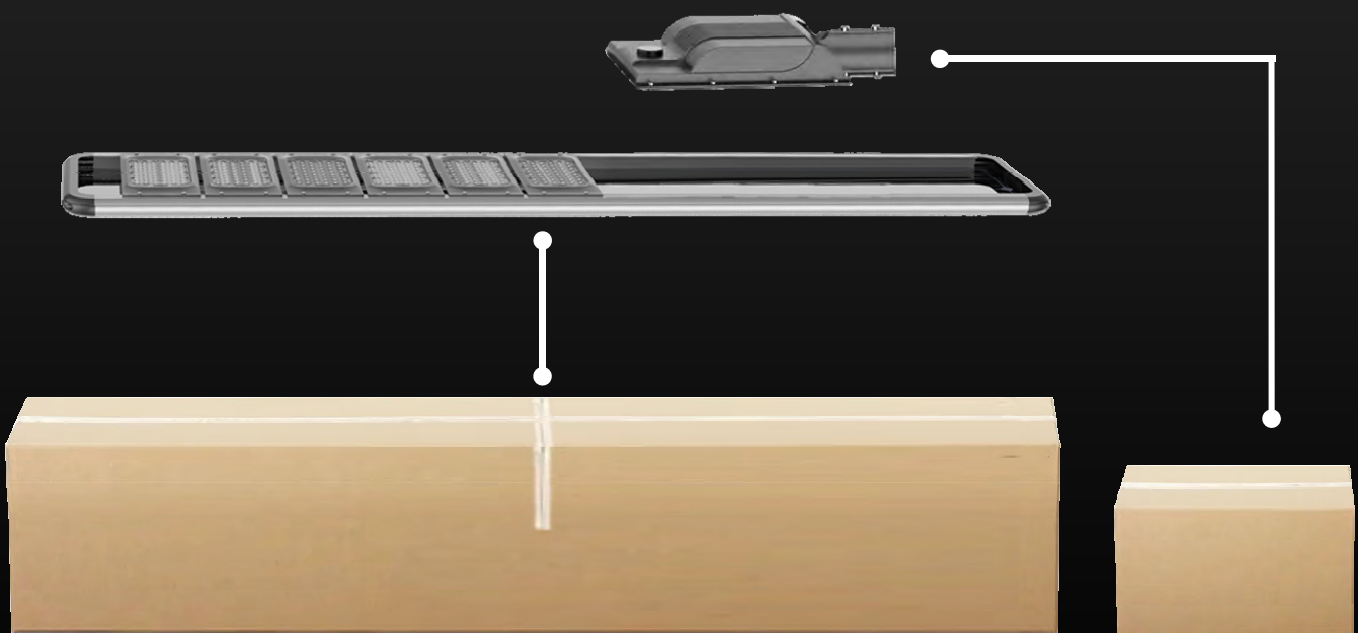

1. Dig a hole according to the size of the foundation cage, put the foundation cage into the hole and fix it with concrete.

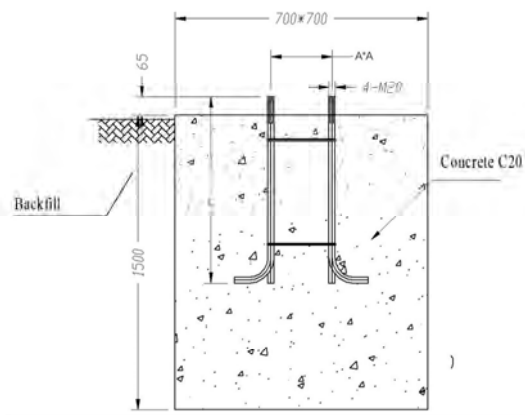

2. Use the supplied screws to fix the bracket on the lamp.

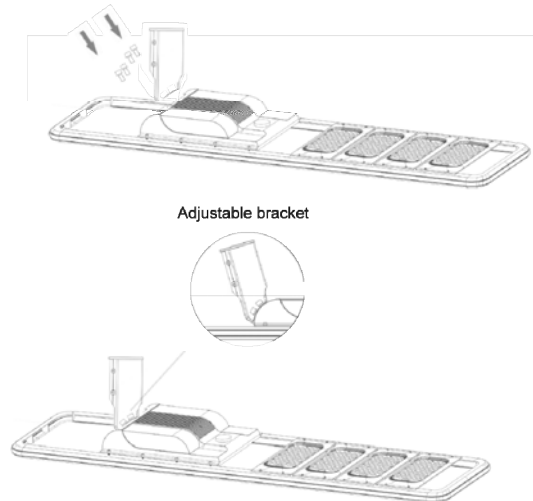

3. Use the supplied screws to fix the lamp on the pole.

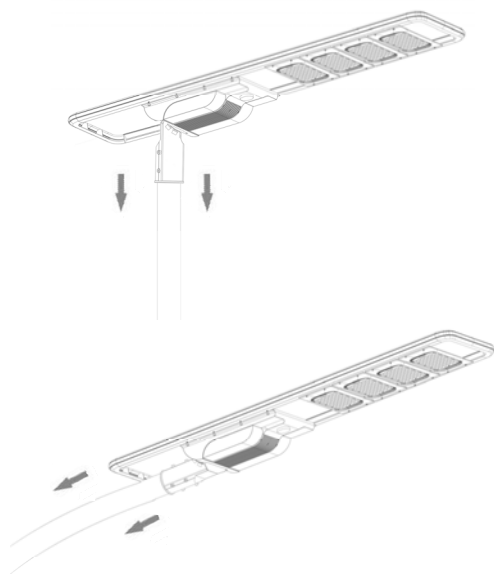

4. Lift the lamp pole by the person or machine, align the bottom flange of the lamp pole with the foundation cage, and then fix the lamp pole with screws.

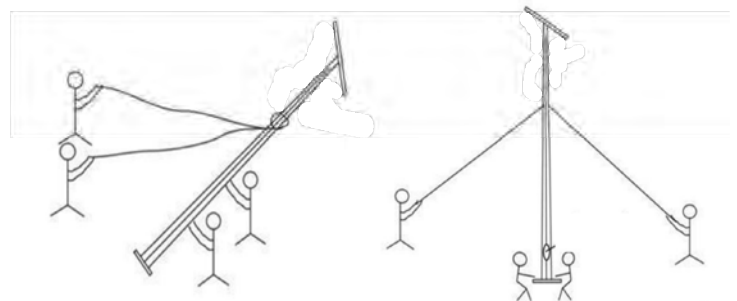

A hexagonal image showing a cityscape at night with lights reflecting on a road.

**CITY ROAD**

A hexagonal image showing a street at night with streetlights illuminating the road.

**STREET**

A hexagonal image showing a large, open square with a central sphere and buildings in the background.

**SQUARE**

A hexagonal image showing a park with a paved path, green grass, and trees.

**PARK**

A hexagonal image showing a rural road with a utility pole and trees.

**RURAL ROAD**

A hexagonal image showing a parking lot with several cars parked.

**PARKING LOTS**

A hexagonal image showing a modern school building with a large glass facade.

**SCHOOL**

A hexagonal image showing a garden with a paved path and a building in the background.

**GARDEN**

A hexagonal image showing a winding road in a remote, mountainous area.

**REMOTE AREA**

Widely used in branch roads, streets, and factory roads, parks, villages, mountainous and remote areas, lighting projects, courtyards, schools, squares and other places that require outdoor lighting, helping domestic traditional lighting to upgrade to LED green new energy lighting Replace.

# SSA Series | Applications





**Thank You Very Much**