

SC SERIES LED Flood Light

5 YEAR
WARRANTY



Areas of application

- Recreational sports
- Billboard lighting
- Accent lighting
- Parking lots
- Roundabout
- Outdoor sports

Product Benefits

- Up to 100,000hrs @ L70, low maintenance cost
- World class, approbated quality components (LEDs /Driver /etc.)
- Tempered glass cover, easy for cleaning
- Compact die-cast structure, solid mechanism and reliable quality
- Atex certification allows the lamps to be used safely in flammable and explosive areas
- Optional installations accessories for recessed, surface and bracket mounting
- 5 years warranty

Product Features

- Luminaire efficacy: Up to 165 lm /w
- Lifetime more than 100, 000 hours
- Impact resistance: IK10
- Type of protection: IP66



Product Datasheet

Electrical Data:

| | | | | |
|--------------------------------------|---|-------------|-------------|-------------|
| Model No | MK-RC-80BF | MK-RC-100BF | MK-RC-120BF | MK-RC-150BF |
| Nominal Wattage | 80W | 100W | 120W | 150W |
| Efficiency(±5%) | 165 lm /w | 160 lm /w | 160 lm /w | 155 lm /w |
| Lumen(±5%) | 13200 lm | 16000 lm | 19200 lm | 23250 lm |
| Nominal Voltage | AC 100-240V /277V 50 /60Hz | | | |
| LED | Philips Lumileds | | | |
| Driver | Inventronics (Default) /Other brands on request | | | |
| Power Factor (PF) | >0.95 | | | |
| THD | <15 | | | |
| SPD | 10KV (Build-in Driver) /Extra 10KV SPD (Available on request) | | | |
| Optics | 25°, 60°, 90°, 120° or Asymmetrical | | | |
| Standard Deviation of Color Matching | <5 SDCM | | | |
| CRI | Ra>70 (Default) /Ra>80 | | | |
| CCT | 3000K, 4000K, 5000K, 5700K | | | |

*Above values are calculated based on the product with CCT over 3000K, values of 3000K are 5% lower than above values.
 *Luminous Efficacy of Asymmetrical is 5% lower than other Light Distributions.
 *Values shown are subject to ±5% tolerance.

General Data

| | |
|-----------------------|---|
| Body Material | High pressure die-cast aluminum |
| Housing Color | White |
| Cover Material | Tempered glass |
| Lens Material | UV-resistant Polycarbonate |
| Working Environment | -40°C ~ +50°C, 10% ~90%RH |
| Lifespan L70 at 25 °C | >100,000 h |
| Mounting Type | Bracket mounting |
| Mounting Location | Wall / Pole / Floor / Ceiling |
| Dimmable | 1-10V Dimming (Default) /Timer Dimming |
| Protection Class | Class I (Default) /Class II |
| Standards | CE, RoHS, CB, LM79, LM80, TM-21, ATEX, IP66, IK10 |
| Available on request | Motion sensor, NTC, OLC, DALI Dimming |

Product Dimensions:

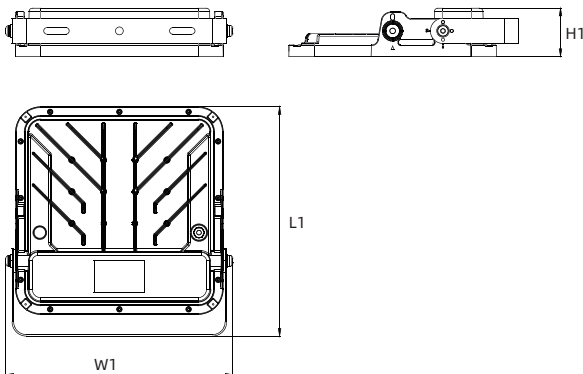

Fixture Information

| Version | L1 xW1 xH1 | Weight |
|------------------|----------------|--------|
| Bracket Mounting | 365 x361 x77mm | 4.0kg |

Packing Informations:

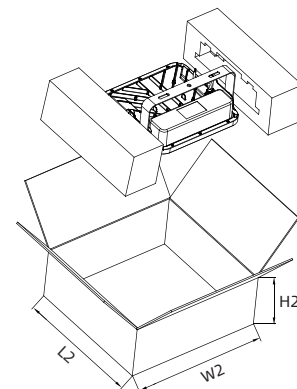

Package Information

| Version | L2 xW2 xH2 | Weight |
|------------------|-----------------|--------|
| Bracket Mounting | 380 x380 x150mm | 4.6kg |

Product Datasheet

Light Distributions

Order reference

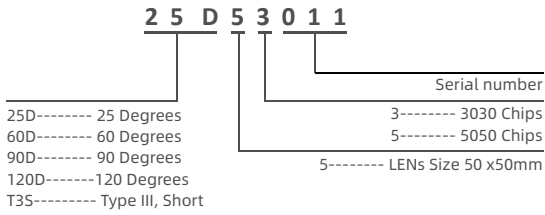

3030 Version

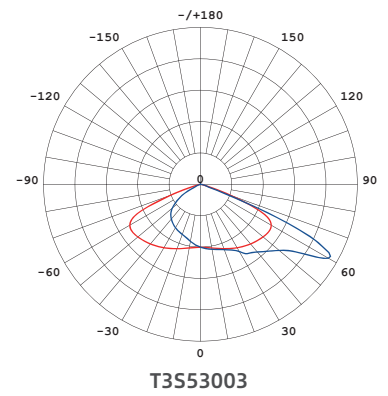
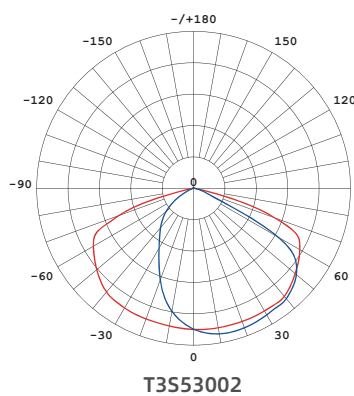
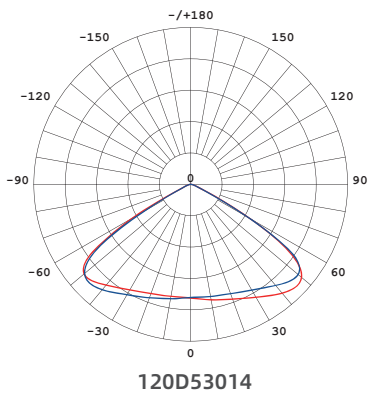
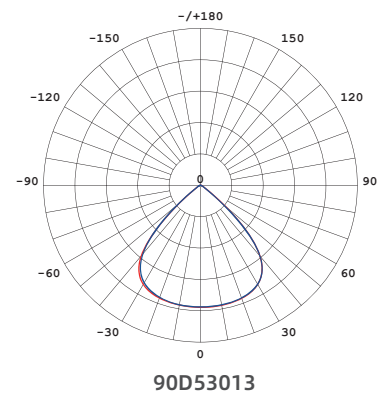
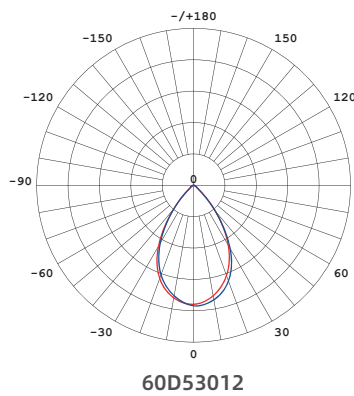
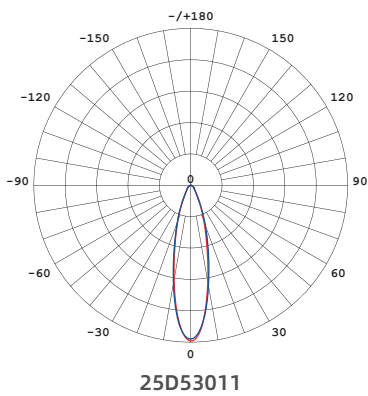

Optional accessories

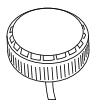

Motion Sensor

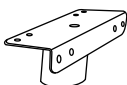

Pole Adapter

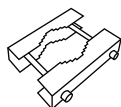

Clamp Bracket

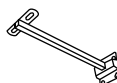

Mounting Arm



Extra 10KV SPD

Product Datasheet

Installation

Surface Mounting (Canopy Light)

Recessed Mounting (Canopy Light)

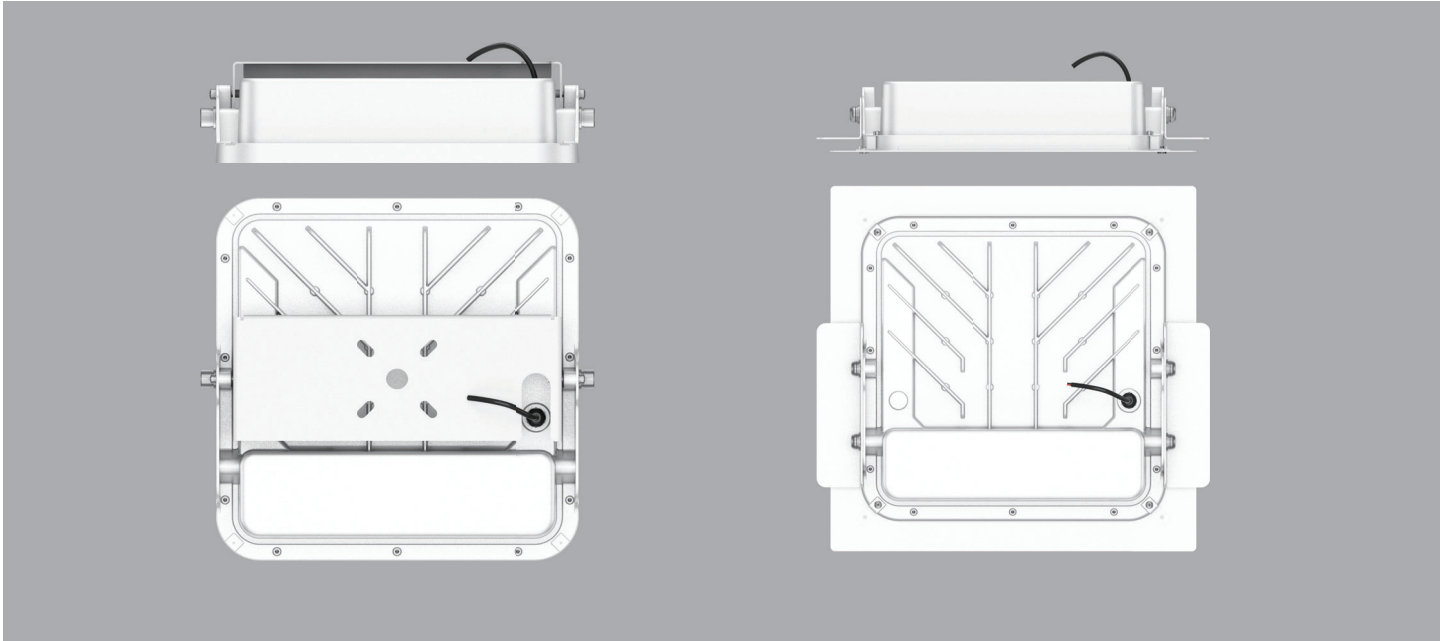

Bracket Mounting (High Bay Light)

Bracket Mounting (Flood Light)

